

## Activity 15

### Ice roads—*Steiner trees*

**Age group** Middle elementary and up.

**Abilities assumed** Measuring and adding up the lengths of several pieces of string. The children need to be able to tie the string to pegs.

**Time** 20 minutes or more. This activity requires a fine day as the children will be working outside on the grass.

**Size of group** From individuals to a class working in groups of three or four.

#### Focus

Spatial visualization.

Geometric reasoning.

Algorithmic procedures and complexity.

#### Summary

Sometimes a small, seemingly insignificant, variation in the specification of a problem makes a huge difference in how hard it is to solve. This activity, like the Muddy City problem (Activity 9), is about finding short paths through networks. The difference is that here we are allowed to introduce new points into the network if that reduces the path length. The result is a far more difficult problem that is not related to the Muddy City, but is algorithmically equivalent to the cartographer's puzzle (Activity 13) and Tourist Town (Activity 14).

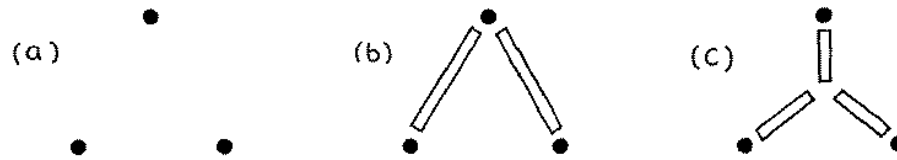

Figure 15.1: Connecting three drill sites with ice roads: (b) is ok but (c) is better

## Technical terms

Steiner trees; shortest paths; NP-complete problems; minimal spanning trees; networks.

## Materials

Each group of children will need

five or six pegs to place in the ground (tent pegs are good, although a coat hanger cut into pieces which are then bent over is fine),

several meters of string or elastic,

a ruler or tape measure, and

pen and paper to make notes on.

## What to do

The previous activity, Tourist Town, took place in a very hot country; this one is just the opposite. In the frozen north of Canada (so the story goes), in the winter on the huge frozen lakes, snowplows make roads to connect up drill sites so that crews can visit each other. Out there in the cold they want to do a minimum of road building, and your job is to figure out where to make the roads. There are no constraints: highways can go anywhere on the snow—the lakes are frozen and covered. It's all flat.

The roads should obviously travel in straight stretches, for to introduce bends would only increase the length unnecessarily. But it's not as simple as connecting all the sites with straight lines, because adding intersections out in the frozen wastes can sometimes reduce the total road length—and it's total length that's important, not travel time from one site to another.

Figure 15.1a shows three drill sites. Connecting one of them to each of the others (as in Figure 15.1b) would make an acceptable road network. Another possibility is to make an intersection somewhere near the center of the triangle and connect it to the three sites (Figure 15.1c). And if you measure the total amount of road that has been cleared, this is indeed a better solution. The extra intersection is called a “Steiner” point after the Swiss mathematician Jacob Steiner (1796–1863), who stated the problem and was the first to notice that the total length can

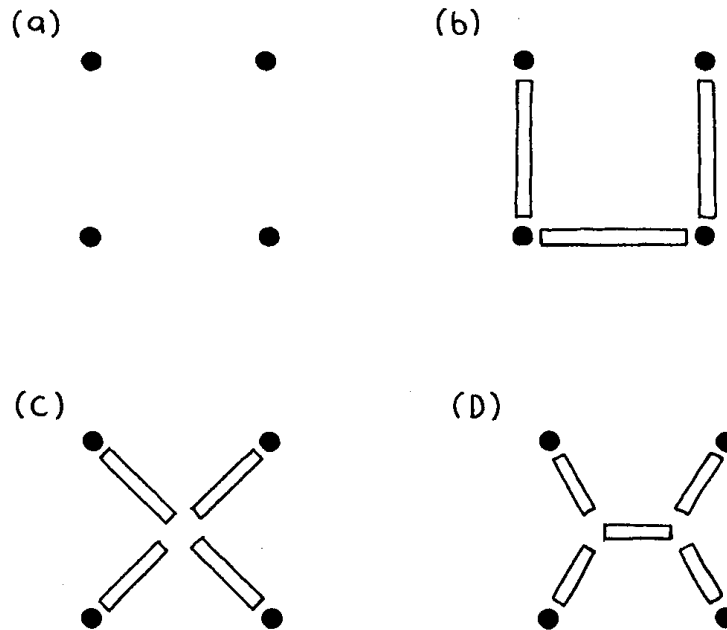

Figure 15.2: Connecting four drill sites with ice roads: (b) is ok, (c) is better and (d) better still

be reduced by introducing new points. You could think of a Steiner point as a new, fictitious, drill site.

1. Describe the problem that the children will be working on. Using the example of Figure 15.1, demonstrate to the children that with three sites, adding a new one sometimes improves the solution by reducing the amount of road-building.
2. The children will be using four points arranged in a square, as illustrated in Figure 15.2a. Go outside and get each group to place four pegs in the grass in a square about 1 meter by 1 meter.
3. Get the children to experiment with connecting the pegs with string or elastic, measuring and recording the minimum total length required. At this stage they should not use any Steiner points. (The minimum is achieved by connecting three sides of the square, as in Figure 15.2b, and the total length is 3 meters.)
4. Now see if the children can do better by using one Steiner point. (The best place is in the center of the square, Figure 15.2c. Then the total length is  $2\sqrt{2} = 2.83$  meters.) Suggest that they might do even better using two Steiner points. (Indeed they can, by placing the two points as in Figure 15.2d, forming 120 degree angles between the incoming roads. The total length is then  $1 + \sqrt{3} = 2.73$  meters.)
5. Can the children do better with three Steiner points? (Two points are best. No advantage is gained by using more.)

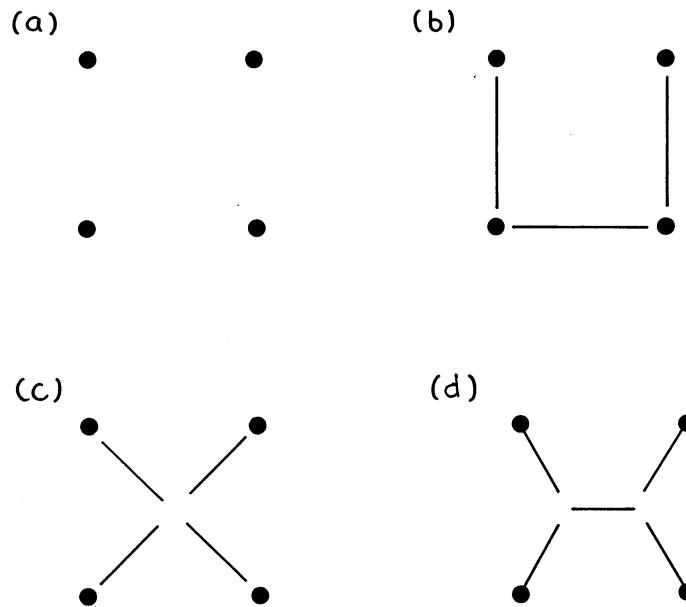

Figure 15.3: Connecting sites in a rectangle: (b) is ok, (c) not so good, and (d) the best

6. Discuss with the children why these problems seem hard. (It's because you don't know where to put the Steiner points, and there are lots of possibilities to try out.)

### Variations and extensions

1. An interesting experiment for groups that finish the original activity early is to work with a rectangle about 1 meter by 2 meters (Figure 15.3). The children will find that adding one Steiner point makes things worse, but two give an improved solution. (The lengths are 4 meters for Figure 15.3b,  $2\sqrt{5} = 4.47$  meters for Figure 15.3c, and  $2 + \sqrt{3} = 3.73$  meters for Figure 15.3d.) See if they can figure out why the one-point configuration does so much worse for rectangles than for squares. (It's because when the square of Figure 15.2 is stretched into the rectangle of Figure 15.3, the amount of stretch gets added just once into Figures 15.3b and 15.3d, but both diagonals increase in Figure 15.3c.)
2. Older children can work on a larger problem. Two layouts of sites to connect with ice roads are given in the blackline masters on pages 161 and 162. They can experiment with different solutions either using new copies of the blackline master, or by writing with removable pen on a transparency over the top of the blackline master. (The minimal solution for the first example is shown in Figure 15.4, while two possible solutions for the second, whose total length is quite similar, are given in Figure 15.5.) Figure 15.5

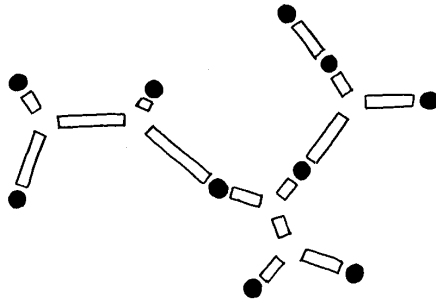

Figure 15.4: Minimal Steiner tree for the first example

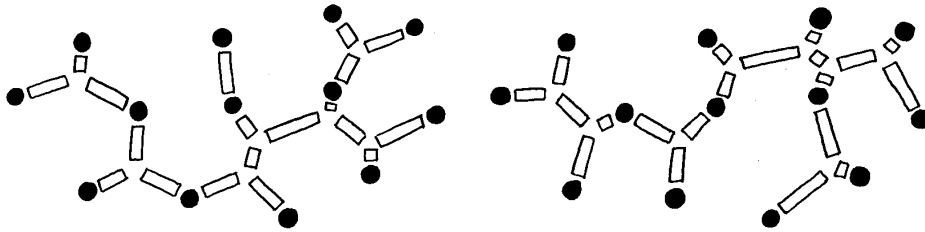

Figure 15.5: Two possible Steiner trees for the second example

illustrates why these kinds of problem are so hard—there are so many choices about where to put the Steiner points!

3. Ladder networks like that in Figure 15.6 provide another way to extend the problem. Some minimal Steiner trees are shown in Figure 15.7. The one for a two-rung ladder is just the same as for a square. However, for a three-rung ladder the solution is quite different—as you will discover if you try to draw it out again from memory! The solution for four rungs is like that for two two-rung ladders joined together, whereas for five rungs it is more like an extension of the three-rung solution. In general, the shape of the minimal Steiner tree for a ladder depends on whether it has an even or odd number of rungs. If it



Figure 15.6: A ladder with six rungs

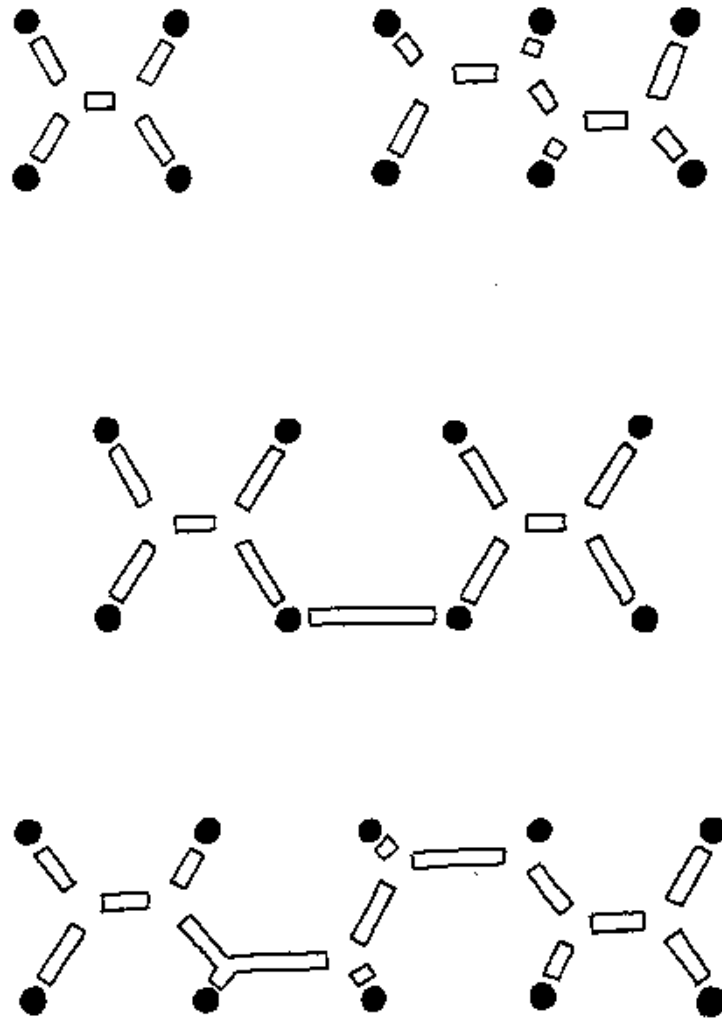

Figure 15.7: Minimal Steiner trees for ladders with two, three, four and five rungs

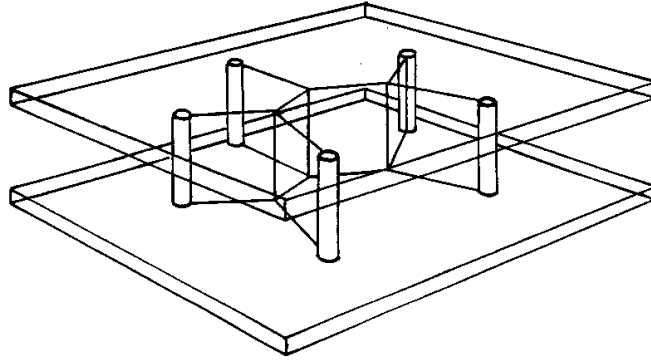

Figure 15.8: Making a Steiner tree with soap bubbles

is even, it is as though several two-rung ladders were joined together. Otherwise, it's like a repetition of the three-rung solution. But proving these things rigorously is not easy.

4. Another interesting activity is to construct soap-bubble models of Steiner trees. You can do this by taking two sheets of rigid transparent plastic and inserting pins between them to represent the sites to be spanned, as shown in Figure 15.8. Now dip the whole thing into a soap solution. When it comes out, you will find that a film of soap connects the pins in a beautiful Steiner-tree network.

Unfortunately, however, it isn't necessarily a *minimal* Steiner tree. The soap film does find a configuration that minimizes the total length, but the minimum is only a local one, not necessarily a global one. There may be completely different ways of placing the Steiner points to give a smaller total length. For example, you can imagine the soap film looking like the first configuration in Figure 15.5 when it is withdrawn from the liquid on one occasion, and the second configuration on another.

## What's it all about?

The networks that we've been working on are *minimal Steiner trees*. They're called "trees" because they have no cycles, just as the branches on a real tree grow apart but do not (normally) rejoin and grow together again. They're called "Steiner" trees because new points, Steiner points, can be added to the original sites that the trees connect. And they're called "minimal" because they have the shortest length of any tree connecting those sites. In the Muddy City (Activity 14) we learned that a network connecting a number of sites that minimizes the total length is called a minimal spanning tree: Steiner trees are just the same except that new points can be introduced.

It's interesting that while there is a very efficient algorithm for finding minimal spanning trees (Activity 14)—a greedy one that works by repeatedly connecting the two closest so-far-unconnected points—there is no general efficient solution to the minimal Steiner problem.

Steiner trees are much harder because you have to decide where to put the extra points. In fact, rather surprisingly, the difficult part of the Steiner tree problem is not in determining the precise location of the Steiner points, but in deciding *roughly* where to put them: the difference between the two solutions in Figure 15.5, for example. Once you know what regions to put the new points in, fine-tuning them to the optimum position is relatively simple. Soap films do that very effectively, and so can computers.

Surprisingly, finding minimal Steiner trees can save big bucks in the telephone business. When corporate customers in the US operate large private telephone networks, they lease the lines from a telephone company. The amount they are billed is not calculated on the basis of how the wires are actually used, but on the basis of the shortest network that would suffice. The reasoning is that the customer shouldn't have to pay extra just because the telephone company uses a round-about route. Originally, the algorithm that calculated how much to charge worked by determining the minimal spanning tree. However, it was noticed by a customer—an airline, in fact, with three major hubs—that if another hub was created at an intermediate point the total length of the network would be reduced. The telephone company was forced to reduce charges to what they would have been if there was a telephone exchange at the Steiner point! Although, for typical configurations, the minimal Steiner tree is only 5% or 10% shorter than the minimal spanning tree, this can be a worthwhile saving when large amounts of money are involved. The Steiner tree problem is sometimes called the “shortest network problem” because it involves finding the shortest network that connects a set of sites.

If you have tackled the two preceding activities, the cartographer's puzzle and tourist town, you will not be surprised to hear that the minimal Steiner tree problem is NP-complete. As the number of sites increases, so does the number of possible locations for Steiner points, and trying all possibilities involves an exponentially-growing search. This is another of the thousands of problems for which it simply isn't known whether exponential search is the best that can be done, or whether there is an as-yet-undiscovered polynomial-time algorithm. What is known, however, is that if a polynomial-time algorithm is found for this problem, it can be turned into a polynomial-time algorithm for graph coloring, for finding minimal dominating sets—and for all the other problems in the NP-complete class.

We explained at the end of the previous activity that the “NP” in NP-complete stands for “non-deterministic polynomial,” and “complete” refers to the fact that if a polynomial-time algorithm is found for one of the NP-complete problems it can be turned into polynomial-time algorithms for all the others. The set of problems that are solvable in polynomial time is called P. So the crucial question is, do polynomial-time algorithms exist for NP-complete problems—in other words, is  $P = NP$ ? The answer to this question is not known, and it is one of the great mysteries of modern computer science.

Problems for which polynomial-time algorithms exist—even though these algorithms might be quite slow—are called “tractable.” Problems for which they do not are called “intractable,” because no matter how fast your computer, or how many computers you use together, a small increase in problem size will mean that they can't possibly be solved in practice. It is not known whether the NP-complete problems—which include the cartographer's puzzle, tourist town, and ice roads—are tractable or not. But most computer scientists are pessimistic that a polynomial-time algorithm for NP-complete problems will ever be found, and so proving that a problem is NP-complete is regarded as strong evidence that the problem is inherently intractable.



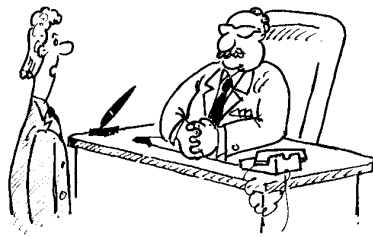

“I can’t find an efficient algorithm, I guess I’m just too dumb.”

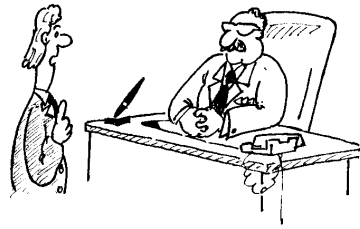

“I can’t find an efficient algorithm, because no such algorithm is possible.”



“I can’t find an efficient algorithm, but neither can all these famous people.”

Figure 15.9: What to do when you can’t find an efficient algorithm: three possibilities

What can you do when your boss asks you to devise an efficient algorithm that comes up with the optimal solution to a problem, and you can’t find one?—as surely happened when the airline hit upon the fact that network costs could be reduced by introducing Steiner points. Figure 15.9 shows three ways you can respond. If you could *prove* that there isn’t an efficient algorithm to come up with the optimal solution, that would be great. But it’s very difficult to prove negative results like this in computer science, for who knows what clever programmer might come along in the future and hit upon an obscure trick that solves the problem. So, unfortunately, you’re unlikely to be in a position to say categorically that no efficient algorithm is possible—that the problem is intractable. But if you can show that your problem is NP-complete, then it’s actually true that thousands of people in research laboratories have worked on problems that really are equivalent to yours, and also failed to come up with an efficient solution. That may not get you a bonus, but it’ll get you off the hook!

## Further reading

An entertaining videotape entitled *The shortest network problem* by R.L. Graham, in the University Video Communications Distinguished Lecture Series, introduces minimal Steiner trees and discusses some of the results that are known about them. Much of the material in this activity was inspired by that video. Figure 15.9 is from Garey and Johnson’s classic book *Computers and Intractability*.

The “Computer recreations” column of *Scientific American*, June 1984, contains a brief description of how to make Steiner trees using soap bubbles, along with interesting descriptions

ACTIVITY 15. ICE ROADS—*STEINER TREES*

---

of other analog gadgets for problem solving, including a spaghetti computer for sorting, a cat's cradle of strings for finding shortest paths in a graph, and a light-and-mirrors device for telling whether or not a number is prime. These also appear in a section about analog computers in Dewdney's *Turing Omnibus*.

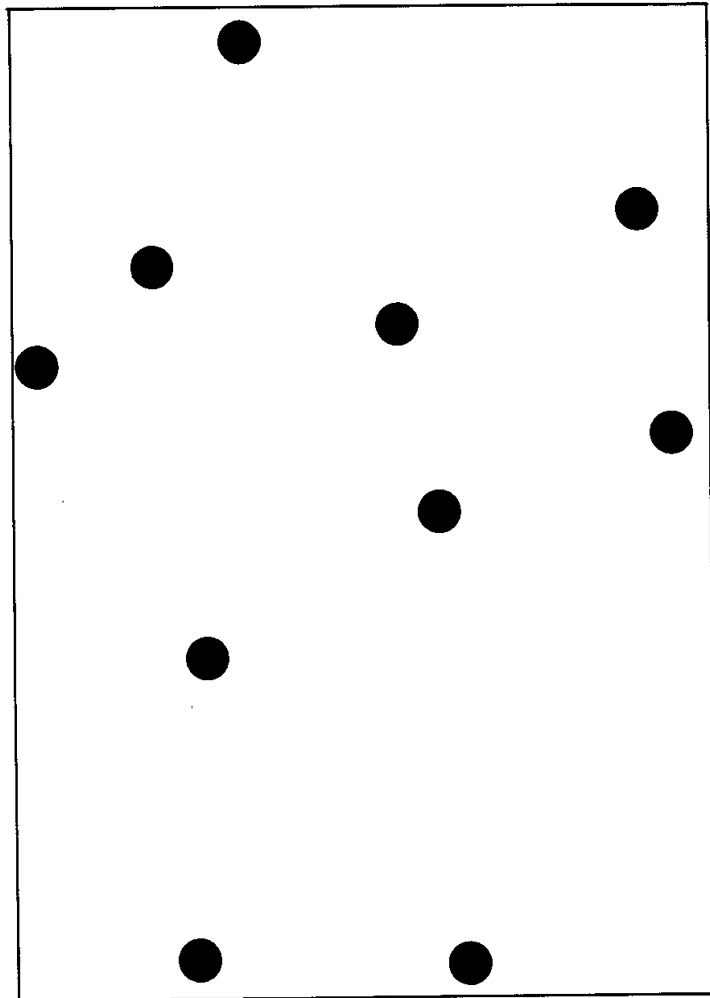

Page 161

**Instructions:** Find a way of linking these drill sites with the shortest possible ice roads.

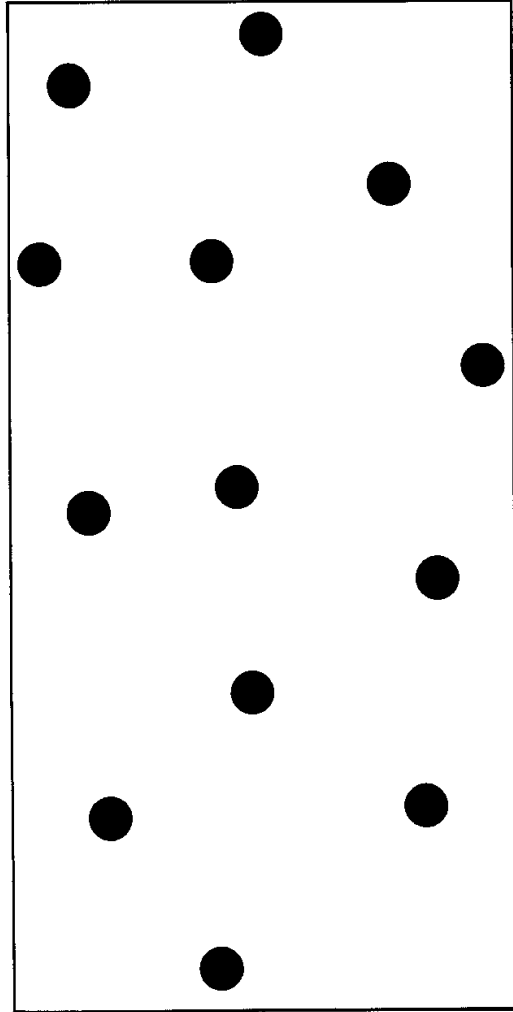

Figure 132

**Instructions:** Find a way of linking these drill sites with the shortest possible ice roads.